

A3.0 NL 3690 AMP

HUMALOG[®]
INSULIN LISPRO INJECTION
(rDNA ORIGIN)

100 UNITS PER ML (U-100)

DESCRIPTION

Humalog[®] (insulin lispro, rDNA origin) is a human insulin analog that is a rapid-acting, parenteral blood glucose-lowering agent. Chemically, it is Lys(B28), Pro(B29) human insulin analog, created when the amino acids at positions 28 and 29 on the insulin B-chain are reversed. Humalog is synthesized in a special non-pathogenic laboratory strain of *Escherichia coli* bacteria that has been genetically altered by the addition of the gene for insulin lispro.

Humalog has the following primary structure:

Figure 1

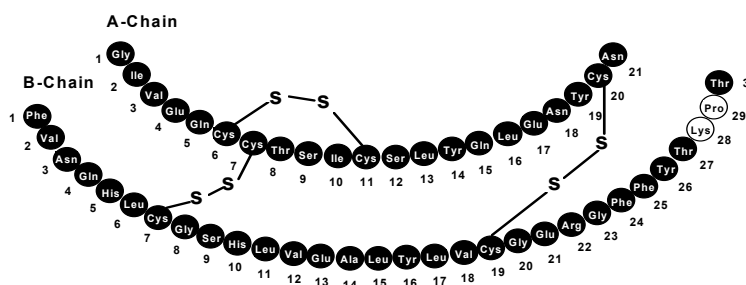

Insulin lispro has the empirical formula $C_{257}H_{383}N_{65}O_{77}S_6$ and a molecular weight of 5808, both identical to that of human insulin.

The vials and cartridges contain a sterile solution of Humalog for use as an injection. Humalog injection consists of zinc-insulin lispro crystals dissolved in a clear aqueous fluid.

Each milliliter of Humalog injection contains insulin lispro 100 Units, 16 mg glycerin, 1.88 mg dibasic sodium phosphate, 3.15 mg *m*-cresol, zinc oxide content adjusted to provide 0.0197 mg zinc ion, trace amounts of phenol, and water for injection. Insulin lispro has a pH of 7.0-7.8. Hydrochloric acid 10% and/or sodium hydroxide 10% may be added to adjust pH.

CLINICAL PHARMACOLOGY

Antidiabetic Activity — The primary activity of insulin, including Humalog, is the regulation of glucose metabolism. In addition, all insulins have several anabolic and anti-catabolic actions on many tissues in the body. In muscle and other tissues (except the brain), insulin causes rapid transport of glucose and amino acids intracellularly, promotes anabolism, and inhibits protein catabolism. In the liver, insulin promotes the uptake and storage of glucose in the form of glycogen, inhibits gluconeogenesis, and promotes the conversion of excess glucose into fat.

Humalog has been shown to be equipotent to human insulin on a molar basis. One unit of Humalog has the same glucose-lowering effect as one unit of human regular insulin, but its

31 effect is more rapid and of shorter duration. The glucose-lowering activity of Humalog and
32 human regular insulin is comparable when administered to normal volunteers by the intravenous
33 route.

34 Pharmacokinetics

35 *Absorption and Bioavailability* — Humalog is as bioavailable as human regular insulin, with
36 absolute bioavailability ranging between 55%-77% with doses between 0.1-0.2 U/kg, inclusive.
37 Studies in normal volunteers and patients with type 1 (insulin-dependent) diabetes demonstrated
38 that Humalog is absorbed faster than human regular insulin (U-100) (Figure 2). In normal
39 volunteers given subcutaneous doses of Humalog ranging from 0.1-0.4 U/kg, peak serum levels
40 were seen 30-90 minutes after dosing. When normal volunteers received equivalent doses of
41 human regular insulin, peak insulin levels occurred between 50-120 minutes after dosing.
42 Similar results were seen in patients with type 1 diabetes. The pharmacokinetic profiles of
43 Humalog and human regular insulin are comparable to one another when administered to normal
44 volunteers by the intravenous route. Humalog was absorbed at a consistently faster rate than
45 human regular insulin in healthy male volunteers given 0.2 U/kg human regular insulin or
46 Humalog at abdominal, deltoid, or femoral subcutaneous sites, the three sites often used by
47 patients with diabetes. After abdominal administration of Humalog, serum drug levels are higher
48 and the duration of action is slightly shorter than after deltoid or thigh administration (*see*
49 **DOSAGE AND ADMINISTRATION**). Humalog has less intra- and inter-patient variability
50 compared to human regular insulin.

51 **Figure 2**

52 **Serum Humalog and Insulin levels after subcutaneous injection of human regular insulin**
53 **or Humalog (0.2 U/kg) immediately before a high carbohydrate meal in 10 patients with**
54 **type 1 diabetes.***

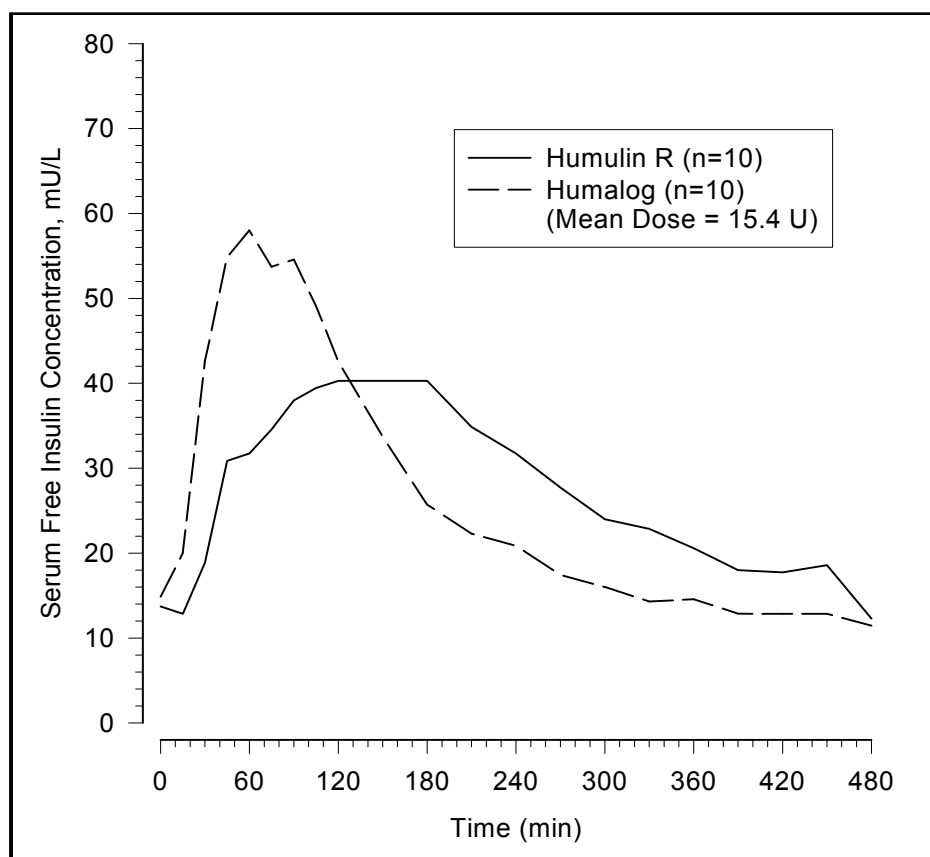

55 * Baseline insulin concentration was maintained by infusion of 0.2 mU/min/kg human insulin.

56

57 **Distribution** — The volume of distribution for Humalog is identical to that of human regular
58 insulin, with a range of 0.26-0.36 L/kg.

59 **Metabolism** — Human metabolism studies have not been conducted. However, animal studies
60 indicate that the metabolism of Humalog is identical to that of human regular insulin.

61 **Elimination** — When Humalog is given subcutaneously, its $t_{1/2}$ is shorter than that of human
62 regular insulin (1 vs 1.5 hours, respectively). When given intravenously, Humalog and human
63 regular insulin show identical dose-dependent elimination, with a $t_{1/2}$ of 26 and 52 minutes at
64 0.1 U/kg and 0.2 U/kg, respectively.

65 **Pharmacodynamics** — Studies in normal volunteers and patients with diabetes demonstrated
66 that Humalog has a more rapid onset of glucose-lowering activity, an earlier peak for glucose
67 lowering, and a shorter duration of glucose-lowering activity than human regular insulin
68 (Figure 3). The earlier onset of activity of Humalog is directly related to its more rapid rate of
69 absorption. The time course of action of insulin and insulin analogs such as Humalog may vary
70 considerably in different individuals or within the same individual. The parameters of Humalog
71 activity (time of onset, peak time, and duration) as designated in Figure 3 should be considered
72 only as general guidelines. The rate of insulin absorption and consequently the onset of activity
73 is known to be affected by the site of injection, exercise, and other variables (*see*
74 PRECAUTIONS, *General*).

75
76
77
78

Figure 3
Blood glucose levels after subcutaneous injection of human regular insulin or Humalog (0.2 U/kg) immediately before a high carbohydrate meal in 10 patients with type 1 diabetes.*

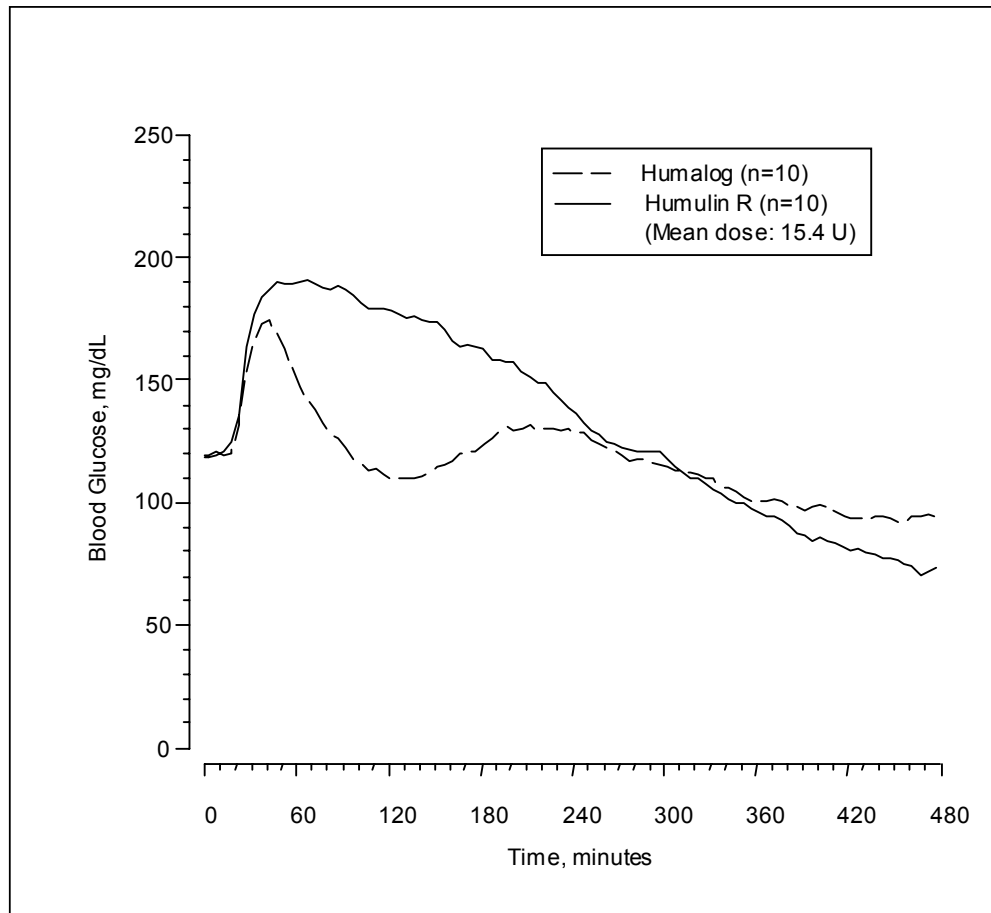

79
80
81
82
83
84
85

* Baseline insulin concentration was maintained by infusion of 0.2 mU/min/kg human insulin.

In open-label, crossover studies of 1008 patients with type 1 diabetes and 722 patients with type 2 (non-insulin-dependent) diabetes, Humalog reduced postprandial glucose compared with human regular insulin (*see* Table 1). The clinical significance of improvement in postprandial hyperglycemia has not been established.

Table 1

Comparison of Means of Glycemic Parameters at the End of Combined Treatment Periods. All Randomized Patients in Cross-over Studies (3 months for each treatment)		
Type 1, N=1008		
Glycemic Parameter, (mg/dL)	Humalog ^a	Humulin [®] R ^{a*}
Fasting Blood Glucose	209.5 ± 91.6	204.1 ± 89.3
1-Hour Postprandial	232.4 ± 97.7	250.0 ± 96.7
2-Hour Postprandial	200.9 ± 95.4	231.7 ± 103.9
HbA _{1c} (%)	8.2 ± 1.5	8.2 ± 1.5
Type 2, N=722		
Glycemic Parameter, (mg/dL)	Humalog ^a	Humulin R ^a
Fasting Blood Glucose	192.1 ± 67.9	183.1 ± 66.1
1-Hour Postprandial	238.1 ± 79.7	250.0 ± 75.2
2-Hour Postprandial	217.4 ± 83.2	236.5 ± 80.6
HbA _{1c} (%)	8.2 ± 1.3	8.2 ± 1.4

^a Mean ± Standard Deviation

* Humulin[®] R (human insulin [rDNA origin] injection)

In 12-month parallel studies in patients with type 1 and type 2 diabetes, HbA_{1c} did not differ between patients treated with human regular insulin and those treated with Humalog.

Hypoglycemia — While the overall rate of hypoglycemia did not differ between patients with type 1 and type 2 diabetes treated with Humalog compared with human regular insulin, patients with type 1 diabetes treated with Humalog had fewer hypoglycemic episodes between midnight and 6 a.m. The lower rate of hypoglycemia in the Humalog-treated group may have been related to higher nocturnal blood glucose levels, as reflected by a small increase in mean fasting blood glucose levels.

Humalog in Combination with Sulfonylurea Agents — In a two-month study in patients with fasting hyperglycemia despite maximal dosing with sulfonylureas (SU), patients were randomized to one of three treatment regimens; Humulin NPH at bedtime plus SU, Humalog three times a day before meals plus SU, or Humalog three times a day before meals and Humulin NPH at bedtime. The combination of Humalog and SU resulted in an improvement in HbA_{1c} accompanied by a weight gain (see Table 2).

Table 2

Results of a Two-Month Study in Which Humalog Was Added to Sulfonylurea Therapy in Patients Not Adequately Controlled on Sulfonylurea Alone			
	Humulin [®] N h.s. + SU	Humalog a.c. + SU	Humalog a.c. + Humulin [®] N h.s.
Randomized (n)	135	139	149
HbA _{1c} (%) at baseline	9.9	10.0	10.0
HbA _{1c} (%) at 2-months	8.7	8.4	8.5
HbA _{1c} (%) change from baseline	-1.2	-1.6	-1.4
Weight gain at 2-months (kg)	0.6	1.2	1.5
Hypoglycemia* (events/mo)	0.11	0.03	0.09
Number of injections	1	3	4
Total insulin dose (U/kg) at 2-months	0.23	0.33	0.52

a.c.-three times a day before meals, h.s.-at bedtime, SU-oral sulfonylurea agent

* blood glucose \leq 36mg/dL or needing assistance from third party

Special Populations

Age and Gender — Information on the effect of age and gender on the pharmacokinetics of Humalog is unavailable. However, in large clinical trials, subgroup analysis based on age and gender did not indicate any difference in postprandial glucose parameters between Humalog and human regular insulin.

Smoking — The effect of smoking on the pharmacokinetics and glucodynamics of Humalog has not been studied.

Pregnancy — The effect of pregnancy on the pharmacokinetics and glucodynamics of Humalog has not been studied.

Obesity — The effect of obesity and/or subcutaneous fat thickness on the pharmacokinetics and glucodynamics of Humalog has not been studied. In large clinical trials, which included patients with Body Mass Index up to and including 35 kg/m², no consistent differences were seen between Humalog and Humulin R with respect to postprandial glucose parameters.

Renal Impairment — Some studies with human insulin have shown increased circulating levels of insulin in patients with renal failure. In a study of 25 patients with type 2 diabetes and a wide range of renal function, the pharmacokinetic differences between Humalog and human regular insulin were generally maintained. However, the sensitivity of the patients to insulin did change, with an increased response to insulin as the renal function declined. Careful glucose monitoring and dose adjustments of insulin, including Humalog, may be necessary in patients with renal dysfunction.

Hepatic Impairment — Some studies with human insulin have shown increased circulating levels of insulin in patients with hepatic failure. In a study of 22 patients with type 2 diabetes, impaired hepatic function did not affect the subcutaneous absorption or general disposition of Humalog when compared to patients with no history of hepatic dysfunction. In that study, Humalog maintained its more rapid absorption and elimination when compared to human regular insulin. Careful glucose monitoring and dose adjustments of insulin, including Humalog, may be necessary in patients with hepatic dysfunction.

INDICATIONS AND USAGE

Humalog is an insulin analog that is indicated in the treatment of patients with diabetes mellitus for the control of hyperglycemia. Humalog has a more rapid onset and a shorter duration of action than human regular insulin. Therefore, in patients with type 1 diabetes, Humalog should be used in regimens that include a longer-acting insulin. However, in patients with type 2

139 diabetes, Humalog may be used without a longer-acting insulin when used in combination
140 therapy with sulfonylurea agents.

141 **CONTRAINDICATIONS**

142 Humalog is contraindicated during episodes of hypoglycemia and in patients sensitive to
143 Humalog or one of its excipients.

144 **WARNINGS**

145 **This human insulin analog differs from human regular insulin by its rapid onset of action**
146 **as well as a shorter duration of activity. When used as a mealtime insulin, the dose of**
147 **Humalog should be given within 15 minutes before or immediately after the meal. Because**
148 **of the short duration of action of Humalog, patients with type 1 diabetes also require a**
149 **longer-acting insulin to maintain glucose control.**

150 **Hypoglycemia is the most common adverse effect associated with insulins, including**
151 **Humalog. As with all insulins, the timing of hypoglycemia may differ among various**
152 **insulin formulations. Glucose monitoring is recommended for all patients with diabetes.**

153 **Any change of insulin should be made cautiously and only under medical supervision.**
154 **Changes in insulin strength, manufacturer, type (e.g., regular, NPH, analog), species**
155 **(animal, human), or method of manufacture (rDNA versus animal-source insulin) may**
156 **result in the need for a change in dosage.**

157 **PRECAUTIONS**

158 *General* — Hypoglycemia and hypokalemia are among the potential clinical adverse effects
159 associated with the use of all insulins. Because of differences in the action of Humalog and other
160 insulins, care should be taken in patients in whom such potential side effects might be clinically
161 relevant (e.g., patients who are fasting, have autonomic neuropathy, or are using
162 potassium-lowering drugs or patients taking drugs sensitive to serum potassium level).
163 Lipodystrophy and hypersensitivity are among other potential clinical adverse effects associated
164 with the use of all insulins.

165 As with all insulin preparations, the time course of Humalog action may vary in different
166 individuals or at different times in the same individual and is dependent on site of injection,
167 blood supply, temperature, and physical activity.

168 Adjustment of dosage of any insulin may be necessary if patients change their physical activity
169 or their usual meal plan. Insulin requirements may be altered during illness, emotional
170 disturbances, or other stresses.

171 **Hypoglycemia** — As with all insulin preparations, hypoglycemic reactions may be associated
172 with the administration of Humalog. Rapid changes in serum glucose levels may induce
173 symptoms of hypoglycemia in persons with diabetes, regardless of the glucose value. Early
174 warning symptoms of hypoglycemia may be different or less pronounced under certain
175 conditions, such as long duration of diabetes, diabetic nerve disease, use of medications such as
176 beta-blockers, or intensified diabetes control.

177 **Renal Impairment** — The requirements for insulin may be reduced in patients with renal
178 impairment.

179 **Hepatic Impairment** — Although impaired hepatic function does not affect the absorption or
180 disposition of Humalog, careful glucose monitoring and dose adjustments of insulin, including
181 Humalog, may be necessary.

182 **Allergy** — Local Allergy — As with any insulin therapy, patients may experience redness,
183 swelling, or itching at the site of injection. These minor reactions usually resolve in a few days to
184 a few weeks. In some instances, these reactions may be related to factors other than insulin, such
185 as irritants in a skin cleansing agent or poor injection technique.

186 Systemic Allergy — Less common, but potentially more serious, is generalized allergy to
187 insulin, which may cause rash (including pruritus) over the whole body, shortness of breath,
188 wheezing, reduction in blood pressure, rapid pulse, or sweating. Severe cases of generalized
189 allergy, including anaphylactic reaction, may be life threatening. In controlled clinical trials,
190 pruritus (with or without rash) was seen in 17 patients receiving Humulin R (N=2969) and
191 30 patients receiving Humalog (N=2944) (p=0.053). Localized reactions and generalized
192 myalgias have been reported with the use of cresol as an injectable excipient.

193 Antibody Production — In large clinical trials, antibodies that cross react with human insulin
194 and insulin lispro were observed in both Humulin R- and Humalog-treatment groups. As
195 expected, the largest increase in the antibody levels during the 12-month clinical trials was
196 observed with patients new to insulin therapy.

197 *Information for Patients* — Patients should be informed of the potential risks and advantages
198 of Humalog and alternative therapies. Patients should also be informed about the importance of
199 proper insulin storage, injection technique, timing of dosage, adherence to meal planning, regular
200 physical activity, regular blood glucose monitoring, periodic glycosylated hemoglobin testing,
201 recognition and management of hypo- and hyperglycemia, and periodic assessment for diabetes
202 complications.

203 Patients should be advised to inform their physician if they are pregnant or intend to become
204 pregnant.

205 Refer patients to the INFORMATION FOR THE PATIENT circular for information on proper
206 injection technique, timing of Humalog dosing (≤ 15 minutes before or immediately after a meal),
207 storing and mixing insulin, and common adverse effects.

208 *Use of the Humalog Pen:* Patients should read the “INFORMATION FOR THE PATIENT”
209 insert and the “Disposable Insulin Delivery Device User Manual” before starting therapy with a
210 Humalog Pen and re-read them each time the prescription is renewed. Patients should be
211 instructed on how to properly use the delivery device (refer to “Disposable Insulin Delivery
212 Device User Manual”), prime the Pen, and properly dispose of needles. Patients should be
213 advised not to share their Pens with others.

214 *Laboratory Tests* — As with all insulins, the therapeutic response to Humalog should be
215 monitored by periodic blood glucose tests. Periodic measurement of glycosylated hemoglobin is
216 recommended for the monitoring of long-term glycemic control.

217 *Drug Interactions* — (see CLINICAL PHARMACOLOGY) Insulin requirements may be
218 increased by medications with hyperglycemic activity such as corticosteroids, isoniazid, certain
219 lipid-lowering drugs (e.g., niacin), estrogens, oral contraceptives, phenothiazines, and thyroid
220 replacement therapy.

221 Insulin requirements may be decreased in the presence of drugs with hypoglycemic activity,
222 such as oral hypoglycemic agents, salicylates, sulfa antibiotics, and certain antidepressants
223 (monoamine oxidase inhibitors), certain angiotensin-converting-enzyme inhibitors,
224 beta-adrenergic blockers, inhibitors of pancreatic function (e.g., octreotide), and alcohol.
225 Beta-adrenergic blockers may mask the symptoms of hyperglycemia in some patients.

226 *Mixing of Insulins* — Care should be taken when mixing all insulins as a change in peak
227 action may occur. The American Diabetes Association warns in its Position Statement on Insulin
228 Administration, “On mixing, physiochemical changes in the mixture may occur (either
229 immediately or over time). As a result, the physiological response to the insulin mixture may
230 differ from that of the injection of the insulins separately.” Mixing Humalog with Humulin N or
231 Humulin U does not decrease the absorption rate or the total bioavailability of Humalog. Given
232 alone or mixed with Humulin N, Humalog results in a more rapid absorption and
233 glucose-lowering effect compared with human regular insulin.

234 The effects of mixing Humalog with insulins of animal source or insulin preparations produced
235 by other manufacturers have not been studied (see WARNINGS).

236 If Humalog is mixed with a longer-acting insulin, such as Humulin N or Humulin U, Humalog
237 should be drawn into the syringe first to prevent clouding of the Humalog by the longer-acting
238 insulin. Injection should be made immediately after mixing. Mixtures should not be administered
239 intravenously.

240 *Carcinogenesis, Mutagenesis, Impairment of Fertility* — Long-term studies in animals have
241 not been performed to evaluate the carcinogenic potential of Humalog. Humalog was not
242 mutagenic in a battery of *in vitro* and *in vivo* genetic toxicity assays (bacterial mutation tests,
243 unscheduled DNA synthesis, mouse lymphoma assay, chromosomal aberration tests, and a
244 micronucleus test). There is no evidence from animal studies of Humalog-induced impairment of
245 fertility.

246 *Pregnancy — Teratogenic Effects — Pregnancy Category B* — Reproduction studies have
247 been performed in pregnant rats and rabbits at parenteral doses up to 4 and 0.3 times,
248 respectively, the average human dose (40 units/day) based on body surface area. The results have
249 revealed no evidence of impaired fertility or harm to the fetus due to Humalog. There are,
250 however, no adequate and well-controlled studies in pregnant women. Because animal
251 reproduction studies are not always predictive of human response, this drug should be used
252 during pregnancy only if clearly needed.

253 Although there are no well-controlled clinical studies of the use of Humalog in pregnancy,
254 published studies with human insulins suggest that optimizing overall glycemic control,
255 including postprandial control, before conception and during pregnancy improves fetal outcome.
256 Although the fetal complications of maternal hyperglycemia have been well documented, fetal
257 toxicity also has been reported with maternal hypoglycemia. Insulin requirements usually fall
258 during the first trimester and increase during the second and third trimesters. Careful monitoring
259 of the patient is required throughout pregnancy. During the perinatal period, careful monitoring
260 of infants born to mothers with diabetes is warranted.

261 *Nursing Mothers* — It is unknown whether Humalog is excreted in significant amounts in
262 human milk. Many drugs, including human insulin, are excreted in human milk. For this reason,
263 caution should be exercised when Humalog is administered to a nursing woman. Patients with
264 diabetes who are lactating may require adjustments in Humalog dose, meal plan, or both.

265 *Pediatric Use* — In a 9-month, cross-over study of pre-pubescent children (n=60), aged 3 to
266 11 years, comparable glycemic control as measured by HbA_{1c} was achieved regardless of
267 treatment group: human regular insulin 30 minutes before meals 8.4%, Humalog immediately
268 before meals 8.4%, and Humalog immediately after meals 8.5%. In an 8-month, cross-over study
269 of adolescents (n=463), aged 9 to 19 years, comparable glycemic control as measured by HbA_{1c}
270 was achieved regardless of treatment group; human regular insulin 30 to 45 minutes before
271 meals 8.7% and Humalog immediately before meals 8.7%. The incidence of hypoglycemia was
272 similar for all three treatment regimens. Adjustment of basal insulin may be required. To
273 improve accuracy in dosing in pediatric patients, a diluent may be used. If the diluent is added
274 directly to the Humalog vial, the shelf-life may be reduced (*see* DOSAGE AND
275 ADMINISTRATION).

276 *Geriatric Use* — Of the total number of subjects (n=2834) in eight clinical studies of
277 Humalog, twelve percent (n=338) were 65 years of age or over. The majority of these were
278 type 2 patients. HbA_{1c} values and hypoglycemia rates did not differ by age.
279 Pharmacokinetic/pharmacodynamic studies to assess the effect of age on the onset of Humalog
280 action have not been performed.

281 **ADVERSE REACTIONS**

282 Clinical studies comparing Humalog with human regular insulin did not demonstrate a
283 difference in frequency of adverse events between the two treatments.

284 Adverse events commonly associated with human insulin therapy include the following:

285 **Body as a Whole** — allergic reactions (*see* PRECAUTIONS)

286 **Skin and Appendages** — injection site reaction, lipodystrophy, pruritus, rash

287 **Other** — hypoglycemia (*see* WARNINGS and PRECAUTIONS)

288

OVERDOSAGE

289 Hypoglycemia may occur as a result of an excess of insulin relative to food intake, energy
290 expenditure, or both. Mild episodes of hypoglycemia usually can be treated with oral glucose.
291 Adjustments in drug dosage, meal patterns, or exercise, may be needed. More severe episodes
292 with coma, seizure, or neurologic impairment may be treated with intramuscular/subcutaneous
293 glucagon or concentrated intravenous glucose. Sustained carbohydrate intake and observation
294 may be necessary because hypoglycemia may recur after apparent clinical recovery.

295

DOSAGE AND ADMINISTRATION

296 Humalog is intended for subcutaneous administration. Dosage regimens of Humalog will vary
297 among patients and should be determined by the health care professional familiar with the
298 patient's metabolic needs, eating habits, and other lifestyle variables. Pharmacokinetic and
299 pharmacodynamic studies showed Humalog to be equipotent to human regular insulin
300 (i.e., one unit of Humalog has the same glucose-lowering capability as one unit of human regular
301 insulin), but with more rapid activity. The quicker glucose-lowering effect of Humalog is related
302 to the more rapid absorption rate from subcutaneous tissue. An adjustment of dose or schedule of
303 basal insulin may be needed when a patient changes from other insulins to Humalog, particularly
304 to prevent pre-meal hyperglycemia.

305 When used as a meal-time insulin, Humalog should be given within 15 minutes before or
306 immediately after a meal. Human regular insulin is best given 30-60 minutes before a meal. To
307 achieve optimal glucose control, the amount of longer-acting insulin being given may need to be
308 adjusted when using Humalog.

309 The rate of insulin absorption and consequently the onset of activity is known to be affected by
310 the site of injection, exercise, and other variables. Humalog was absorbed at a consistently faster
311 rate than human regular insulin in healthy male volunteers given 0.2 U/kg human regular insulin
312 or Humalog at abdominal, deltoid, or femoral sites, the three sites often used by patients with
313 diabetes. When not mixed in the same syringe with other insulins, Humalog maintains its rapid
314 onset of action and has less variability in its onset of action among injection sites compared with
315 human regular insulin (*see* PRECAUTIONS). After abdominal administration, Humalog
316 concentrations are higher than those following deltoid or thigh injections. Also, the duration of
317 action of Humalog is slightly shorter following abdominal injection, compared with deltoid and
318 femoral injections. As with all insulin preparations, the time course of action of Humalog may
319 vary considerably in different individuals or within the same individual. Patients must be
320 educated to use proper injection techniques.

321 Humalog may be diluted with STERILE DILUENT for Humalog[®], Humulin[®] N,
322 Humulin[®] 50/50, Humulin[®] 70/30, and NPH Iletin[®] to a concentration of 1:10 (equivalent to
323 U-10) or 1:2 (equivalent to U-50). Diluted Humalog may remain in patient use for 28 days when
324 stored at 5°C (41°F) and for 14 days when stored at 30°C (86°F).

325 Parenteral drug products should be inspected visually prior to administration whenever the
326 solution and the container permit. If the solution is cloudy, contains particulate matter, is
327 thickened, or is discolored, the contents must not be injected. Humalog should not be used after
328 its expiration date.

329

HOW SUPPLIED

330 Humalog (insulin lispro injection, rDNA origin) vials are available in the following package
331 size:

332 100 units per mL (U-100)

333 10 mL vials

NDC 0002-7510-01 (VL-7510)

334 Humalog (insulin lispro injection, rDNA origin) cartridges are available in the following
 335 package sizes:
 336 5 X 1.5 mL cartridges* NDC 0002-7515-59 (VL-7515)
 337 5 X 3 mL cartridges** NDC 0002-7516-59 (VL-7516)
 338 Humalog (insulin lispro injection, rDNA origin) Pen, disposable insulin delivery device, is
 339 available in the following package size:
 340 5 X 3 mL disposable insulin delivery devices NDC 0002-8725-59 (HP-8725)

341
 342 * 1.5 mL cartridges are for use in Becton Dickinson and Company's B-D[®]† Pen and Novo Nordisk A/S's
 343 NovoPen[®]‡, NovolinPen[®]‡, and NovoPen[®]‡ 1.5 insulin delivery devices.
 344 ** 3 mL cartridge is for use in Owen Mumford, Ltd.'s Autopen[®]§ 3 mL insulin delivery device.
 345 † B-D[®] is a registered trademark of Becton Dickinson and Company.
 346 ‡ NovolinPen[®] and NovoPen[®] are registered trademarks of Novo Nordisk A/S.
 347 § Autopen[®] is a registered trademark of Owen Mumford, Ltd.
 348

349 *Storage* — Humalog should be stored in a refrigerator (36° to 46°F [2° to 8°C]), but not in the
 350 freezer. Do not use Humalog if it has been frozen. Unrefrigerated (below 86°F [30°C]) vials,
 351 cartridges, and Pens must be used within 28 days or be discarded, even if they still contain
 352 Humalog. Protect from direct heat and light. See table below:

	Not in-use (unopened) Room Temperature below 86°F (30°C)	Not in-use (unopened) Refrigerated	In-use (opened) Room temperature, below 86°F (30°C)
10 mL Vial	28 days	Until expiration date	28 days, refrigerated/room temperature
1.5 mL and 3 mL cartridge	28 days	Until expiration date	28 days, Do not refrigerate.
3 mL Pen	28 days	Until expiration date	28 days, Do not refrigerate.

353

354 Literature issued XXX 2003

355 **Eli Lilly and Company, Indianapolis, IN 46285, USA**
 356 A3.0 NL 3690 AMP PRINTED IN USA
 357 Copyright © 1996, 2003, Eli Lilly and Company. All rights reserved.

A3.0 NL 3700 AMP

1
2
3
4
5
6
7
8
9
10
11
12
13
14
15
16
17
18
19
20
21
22
23
24
25
26
27
28
29
30
31
32
33
34
35
36
37
38
39
40
41
42
43
44
45
46
47

INFORMATION FOR THE PATIENT
3 ML DISPOSABLE INSULIN DELIVERY DEVICE

HUMALOG[®] Pen
INSULIN LISPRO INJECTION
(rDNA ORIGIN)

100 Units per mL (U-100)

WARNINGS

THIS LILLY HUMAN INSULIN ANALOG IS DIFFERENT FROM OTHER INSULINS BECAUSE IT HAS A RAPID ONSET AND SHORTER DURATION OF ACTION. THE RAPID ONSET OF ACTION MEANS THAT YOU SHOULD TAKE YOUR DOSE OF HUMALOG[®] (INSULIN LISPRO INJECTION, rDNA ORIGIN) WITHIN 15 MINUTES BEFORE OR IMMEDIATELY AFTER EATING. THE SHORT DURATION OF ACTION OF HUMALOG MEANS THAT IF YOU HAVE TYPE 1 DIABETES, YOU ALSO NEED TO USE A LONGER-ACTING INSULIN TO GIVE THE BEST GLUCOSE CONTROL. IF YOU HAVE TYPE 2 DIABETES, HUMALOG MAY BE USED WITHOUT A LONGER-ACTING INSULIN WHEN USED IN COMBINATION THERAPY WITH SULFONYLUREA AGENTS.

ANY CHANGE OF INSULIN SHOULD BE MADE CAUTIOUSLY AND ONLY UNDER MEDICAL SUPERVISION. CHANGES IN STRENGTH, MANUFACTURER, TYPE (E.G., REGULAR, NPH, LENTE), SPECIES (BEEF, PORK, BEEF-PORK, HUMAN), OR METHOD OF MANUFACTURE (rDNA VERSUS ANIMAL-SOURCE INSULIN) MAY RESULT IN THE NEED FOR A CHANGE IN THE TIMING OR DOSAGE OF HUMALOG OR THE LONGER-ACTING INSULIN, OR BOTH.

PATIENTS TAKING HUMALOG MAY REQUIRE A CHANGE IN DOSAGE FROM THAT USED WITH OTHER INSULINS. IF AN ADJUSTMENT IS NEEDED, IT MAY OCCUR WITH THE FIRST DOSE OR DURING THE FIRST SEVERAL WEEKS OR MONTHS.

TO OBTAIN AN ACCURATE DOSE, CAREFULLY READ AND FOLLOW THE “DISPOSABLE INSULIN DELIVERY DEVICE USER MANUAL” AND THIS INFORMATION FOR THE PATIENT INSERT BEFORE USING THIS PRODUCT. BEFORE EACH INJECTION, YOU SHOULD PRIME THE PEN, A NECESSARY STEP TO MAKE SURE THE PEN IS READY TO DOSE. PRIMING THE PEN IS IMPORTANT TO CONFIRM THAT INSULIN COMES OUT WHEN YOU PUSH THE INJECTION BUTTON AND TO REMOVE AIR THAT MAY COLLECT IN THE INSULIN CARTRIDGE DURING NORMAL USE. IF YOU DO NOT PRIME, YOU MAY RECEIVE A WRONG DOSE-(see also INSTRUCTIONS FOR PEN USE section).

DIABETES

Insulin is a hormone produced by the pancreas, a large gland that lies near the stomach. This hormone is necessary for the body’s correct use of food, especially sugar. Diabetes occurs when the pancreas does not make enough insulin to meet your body’s needs.

To control your diabetes, your doctor has prescribed injections of insulin products to keep your blood glucose at a near-normal level. You have been instructed to test your blood and/or your urine regularly for glucose. Studies have shown that some chronic complications of diabetes

48 such as eye disease, kidney disease, and nerve disease can be significantly reduced if the blood
49 sugar is maintained as close to normal as possible. The American Diabetes Association
50 recommends that if your premeal glucose levels are consistently above 130 mg/dL or your
51 hemoglobin A_{1c} (HbA_{1c}) is more than 7%, consult your doctor. A change in your diabetes
52 therapy may be needed. If your blood tests consistently show below-normal glucose levels you
53 should also let your doctor know. Proper control of your diabetes requires close and constant
54 cooperation with your doctor. Despite diabetes, you can lead an active and healthy life if you eat
55 a balanced diet, exercise regularly, and take your insulin injections as prescribed.

56 Always keep an extra supply of Humalog as well as a spare syringe and needle on hand.
57 Always wear diabetic identification so that appropriate treatment can be given if complications
58 occur away from home.

59 HUMALOG

60 Description

61 Humalog (insulin lispro [rDNA origin]) is made by a special non-disease-producing laboratory
62 strain of *Escherichia coli* bacteria that has been genetically altered by the addition of the gene
63 for this human insulin analog. Humalog consists of zinc-insulin lispro crystals dissolved in a
64 clear fluid. Humalog is a sterile solution and is for subcutaneous injection. It should not be used
65 intramuscularly. The concentration of Humalog is 100 units/mL (U-100). Humalog starts
66 lowering blood glucose more quickly and has a shorter duration of action compared to regular
67 human insulin. This means that your dose of Humalog should be given within 15 minutes before
68 or immediately after a meal (regular insulin works best when given 30-60 minutes before a
69 meal). The short duration of action of Humalog means that if you have type 1 diabetes, you need
70 to use a longer-acting insulin to give the best glucose control. If you have type 2 diabetes,
71 Humalog may be used without a longer-acting insulin when used in combination therapy with
72 sulfonylurea agents. The time course of Humalog action, like that of other insulins, may vary in
73 different individuals or at different times in the same individual, based on dose, site of injection,
74 blood supply, temperature, and physical activity.

75 Identification

76 Insulin lispro injection (rDNA origin), manufactured by Eli Lilly and Company, has the
77 trademark Humalog. Your doctor has prescribed the type of insulin that he/she believes is best
78 for you.

79 **DO NOT USE ANY OTHER INSULIN EXCEPT ON YOUR DOCTOR'S ADVICE AND** 80 **DIRECTION.**

81 The Humalog Pen is available in boxes of 5 disposable insulin delivery devices (“insulin
82 Pens”). The Humalog Pen is not designed to allow any other insulin to be mixed in its cartridge
83 of Humalog, or for the cartridge to be removed.

84 Always examine the appearance of Humalog solution in the insulin Pen before administering a
85 dose. Humalog is a clear and colorless liquid with a water-like appearance and consistency. Do
86 not use if it appears cloudy, thickened, or slightly colored, or if solid particles are visible. If you
87 note anything unusual in its appearance or notice your insulin requirements changing markedly,
88 consult your doctor.

89 Storage

90 **Not in-use (unopened):** Humalog Pens not in-use should be stored in a refrigerator but not in
91 the freezer. Do not use Humalog Pen if it has been frozen.

92 **In-use:** Humalog Pens in-use should **NOT** be refrigerated but should be kept at room
93 temperature (below 86°F [30°C]) away from direct heat and light. Humalog Pens in-use must be
94 discarded **after 28 days**, even if they still contain Humalog.

95 Do not use Humalog Pens after the expiration date stamped on the label.

96 INSTRUCTIONS FOR PEN USE

97 **It is important to read, understand, and follow the instructions in the “Disposable Insulin**
98 **Delivery Device User Manual” before using. Failure to follow instructions may result in a**

99 wrong insulin dose. The Pen must be primed before each injection to make sure the Pen is
100 ready to dose. Performing the priming step is important to confirm that insulin comes out
101 when you push the injection button, and to remove air that may collect in the insulin
102 cartridge during normal use.

103 **NEVER SHARE INSULIN PENS, CARTRIDGES, OR NEEDLES.**

104 **PREPARING THE INSULIN PEN FOR INJECTION**

- 105 1. Inspect the appearance of Humalog solution in the Humalog Pen. It should look clear and
106 colorless. Do not use Humalog if it appears cloudy, thickened, or slightly colored, or if
107 solid particles are visible.
- 108 2. Follow the instructions in the “Disposable Insulin Delivery Device User Manual” for
109 these steps:
 - 110 • Preparing the Pen
 - 111 • Attaching the Needle
 - 112 • Priming the Pen. **The Pen must be primed before each injection to make sure the**
113 **Pen is ready to dose.** Performing the priming step is important to confirm that insulin
114 comes out when you push the injection button, and to remove air that may collect in the
115 insulin cartridge during normal use.
 - 116 • Setting a Dose
 - 117 • Injecting a Dose.
 - 118 • Following an Injection

119 **PREPARING FOR INJECTION**

- 120 1. Wash your hands.
- 121 2. To avoid tissue damage, choose a site for each injection that is at least 1/2 inch from the
122 previous injection site. The usual sites of injection are abdomen, thighs, and arms.
- 123 3. Cleanse the skin with alcohol where the injection is to be made.
- 124 4. With one hand, stabilize the skin by spreading it or pinching up a large area.
- 125 5. Inject the dose as instructed by your doctor.
- 126 6. After dispensing a dose, pull the needle out and apply gentle pressure over the injection
127 site for several seconds. Do not rub the area.
- 128 7. Immediately after an injection, remove the needle from the Humalog Pen. Doing so will
129 guard against contamination, and prevent leakage of Humalog, reentry of air, and needle
130 clogs. **Do not reuse needles.** Place the used needle in a puncture-resistant disposable
131 container and properly dispose of it as directed by your Health Care Professional.

132 **DOSAGE**

133 Your doctor has told you which insulin to use, how much, and when and how often to inject it.
134 Because each patient’s diabetes is different, this schedule has been individualized for you. Your
135 usual dose of Humalog may be affected by changes in your food, activity, or work schedule.
136 Carefully follow your doctor’s instructions to allow for these changes. Other things that may
137 affect your dose of Humalog are:

138 **Illness**

139 Illness, especially with nausea and vomiting, may cause your insulin requirements to change.
140 Even if you are not eating, you will still require insulin. You and your doctor should establish a
141 sick day plan for you to use in case of illness. When you are sick, test your blood glucose/urine
142 glucose and ketones frequently and call your doctor as instructed.

143 **Pregnancy**

144 Good control of diabetes is especially important for you and your unborn baby. Pregnancy may
145 make managing your diabetes more difficult. If you are planning to have a baby, are pregnant, or
146 are nursing a baby, consult your doctor. Humalog has not been tested in pregnant or nursing
147 women.

148 **Geriatric Use**

149 Elderly patients using Humalog had HbA_{1c} values and hypoglycemia rates similar to those
150 observed in younger patients. The onset of action of Humalog may be different in elderly
151 patients.

152 **Medication**

153 Insulin requirements may be increased if you are taking other drugs with hyperglycemic
154 activity, such as oral contraceptives, corticosteroids, or thyroid replacement therapy. Insulin
155 requirements may be reduced in the presence of drugs with blood-glucose-lowering activity,
156 such as oral hypoglycemics, salicylates (for example, aspirin), sulfa antibiotics, alcohol, and
157 certain antidepressants. Your health care professional is aware of other medications that may
158 affect your diabetes control. Therefore, always discuss any medications you are taking with your
159 doctor.

160 **Exercise**

161 Exercise may lower your body's need for insulin products during and for some time after the
162 physical activity. Exercise may also speed up the effect of a dose of Humalog, especially if the
163 exercise involves the area of injection site. Discuss with your doctor how you should adjust your
164 regimen to accommodate exercise.

165 **Travel**

166 Persons traveling across more than 2 time zones should consult their doctor concerning
167 adjustments in their insulin schedule.

168 **COMMON PROBLEMS OF DIABETES**

169 **Hypoglycemia (Insulin Reaction)**

170 Hypoglycemia (too little glucose in the blood) is one of the most frequent adverse events
171 experienced by insulin users. It can be brought about by:

- 172 1. **Missing or delaying meals**
- 173 2. Taking too much insulin
- 174 3. Exercising or working more than usual
- 175 4. An infection or illness (especially with diarrhea or vomiting)
- 176 5. A change in the body's need for insulin
- 177 6. Diseases of the adrenal, pituitary, or thyroid gland, or progression of kidney or liver
178 disease
- 179 7. Interactions with other drugs that lower blood glucose, such as oral hypoglycemics,
180 salicylates (for example, aspirin), sulfa antibiotics, and certain antidepressants
- 181 8. Consumption of alcoholic beverages

182 Symptoms of mild to moderate hypoglycemia may occur suddenly and can include:

- | | |
|--|-----------------------|
| 183 • sweating | • drowsiness |
| 184 • dizziness | • sleep disturbances |
| 185 • palpitation | • anxiety |
| 186 • tremor | • blurred vision |
| 187 • hunger | • slurred speech |
| 188 • restlessness | • depressed mood |
| 189 • tingling in the hands, feet, lips, or tongue | • irritability |
| 190 • lightheadedness | • abnormal behavior |
| 191 • inability to concentrate | • unsteady movement |
| 192 • headache | • personality changes |

193 Signs of severe hypoglycemia can include:

- | | |
|-----------------------|------------|
| 194 • disorientation | • seizures |
| 195 • unconsciousness | • death |

196 Therefore, it is important that assistance be obtained immediately.

197 Early warning symptoms of hypoglycemia may be different or less pronounced under certain
198 conditions, such as long duration of diabetes, diabetic nerve disease, use of medications such as
199 beta-blockers, changing insulin preparations, or intensified control (3 or more injections per day)
200 of diabetes. A few patients who have experienced hypoglycemic reactions after transfer from
201 animal-source insulin to human insulin have reported that the early warning symptoms of
202 hypoglycemia were less pronounced or different from those experienced with their previous
203 insulin.

204 Without recognition of early warning symptoms, you may not be able to take steps to avoid
205 more serious hypoglycemia. Be alert for all of the various types of symptoms that may indicate
206 hypoglycemia. Patients who experience hypoglycemia without early warning symptoms should
207 monitor their blood glucose frequently, especially prior to activities such as driving. If the blood
208 glucose is below your normal fasting glucose, you should consider eating or drinking
209 sugar-containing foods to treat your hypoglycemia.

210 Mild to moderate hypoglycemia may be treated by eating foods or drinks that contain sugar.
211 Patients should always carry a quick source of sugar, such as candy mints or glucose tablets.
212 More severe hypoglycemia may require the assistance of another person. Patients who are unable
213 to take sugar orally or who are unconscious require an injection of glucagon or should be treated
214 with intravenous administration of glucose at a medical facility.

215 You should learn to recognize your own symptoms of hypoglycemia. If you are uncertain
216 about these symptoms, you should monitor your blood glucose frequently to help you learn to
217 recognize the symptoms that you experience with hypoglycemia.

218 If you have frequent episodes of hypoglycemia or experience difficulty in recognizing the
219 symptoms, you should consult your doctor to discuss possible changes in therapy, meal plans,
220 and/or exercise programs to help you avoid hypoglycemia.

221 **Hyperglycemia and Diabetic Acidosis**

222 Hyperglycemia (too much glucose in the blood) may develop if your body has too little insulin.
223 Hyperglycemia can be brought about by any of the following:

- 224 1. Omitting your insulin or taking less than the doctor has prescribed
- 225 2. Eating significantly more than your meal plan suggests
- 226 3. Developing a fever, infection, or other significant stressful situation

227 In patients with insulin-dependent diabetes, prolonged hyperglycemia can result in diabetic
228 acidosis. The first symptoms of diabetic acidosis usually come on gradually, over a period of
229 hours or days, and include a drowsy feeling, flushed face, thirst, loss of appetite, and fruity odor
230 on the breath. With acidosis, urine tests show large amounts of glucose and acetone. Heavy
231 breathing and a rapid pulse are more severe symptoms. If uncorrected, prolonged hyperglycemia
232 or diabetic acidosis can lead to nausea, vomiting, dehydration, loss of consciousness, or death.
233 Therefore, it is important that you obtain medical assistance immediately.

234 **Lipodystrophy**

235 Rarely, administration of insulin subcutaneously can result in lipoatrophy (depression in the
236 skin) or lipohypertrophy (enlargement or thickening of tissue). If you notice either of these
237 conditions, consult your doctor. A change in your injection technique may help alleviate the
238 problem.

239 **Allergy**

240 *Local Allergy* — Patients occasionally experience redness, swelling, and itching at the site of
241 injection. This condition, called local allergy, usually clears up in a few days to a few weeks. In
242 some instances, this condition may be related to factors other than insulin, such as irritants in the
243 skin cleansing agent or poor injection technique. If you have local reactions, contact your doctor.

244 *Systemic Allergy* — Less common, but potentially more serious, is generalized allergy to
245 insulin, which may cause rash over the whole body, shortness of breath, wheezing, reduction in
246 blood pressure, fast pulse, or sweating. Severe cases of generalized allergy may be life
247 threatening. If you think you are having a generalized allergic reaction, notify a doctor
248 immediately.

249

ADDITIONAL INFORMATION

250

Additional information about diabetes may be obtained from your diabetes educator.

251

252

DIABETES FORECAST is a national magazine designed especially for patients with diabetes and their families and is available by subscription from the American Diabetes Association, National Service Center, 1660 Duke Street, Alexandria, Virginia 22314,

253

1-800-DIABETES (1-800-342-2383). Another publication, **DIABETES COUNTDOWN**, is

254

available from the Juvenile Diabetes Foundation International (JDF), 120 Wall Street,

255

19th Floor, New York, New York 10005-4001, 1-800-JDF-CURE (1-800-533-2873).

256

Additional information about Humalog and Humalog Pen can be obtained by calling

257

1-888-88-LILLY (1-888-885-4559).

258

Literature issued XXX 2003

259

Literature issued XXX 2003

260

Eli Lilly and Company, Indianapolis, IN 46285, USA

261

A3.0 NL 3700 AMP

PRINTED IN USA

262

Copyright © 1998, 2003, Eli Lilly and Company. All rights reserved.

A3.0 NL 3730 AMP

Lilly

Disposable Insulin Delivery Device
User Manual

Instructions for Use

Read and follow these step by step instructions carefully. Failure to follow these instructions completely, including the priming step, may result in a wrong insulin dose. Also, read the *Information for the Patient* insert enclosed in your Pen box.

Pen Features

- A multiple dose, disposable insulin delivery device (“insulin Pen”) containing 3 mL (300 units) of U-100 insulin
- Delivers up to 60 units per dose
- Doses can be dialed by single units



Table of Contents

Pen Parts	3
Important Notes	4
Preparing the Pen	6
Attaching the Needle	8
Priming the Pen	10
Setting a Dose	14
Injecting a Dose	16
Following an Injection	18
Questions and Answers	20

Pen Parts

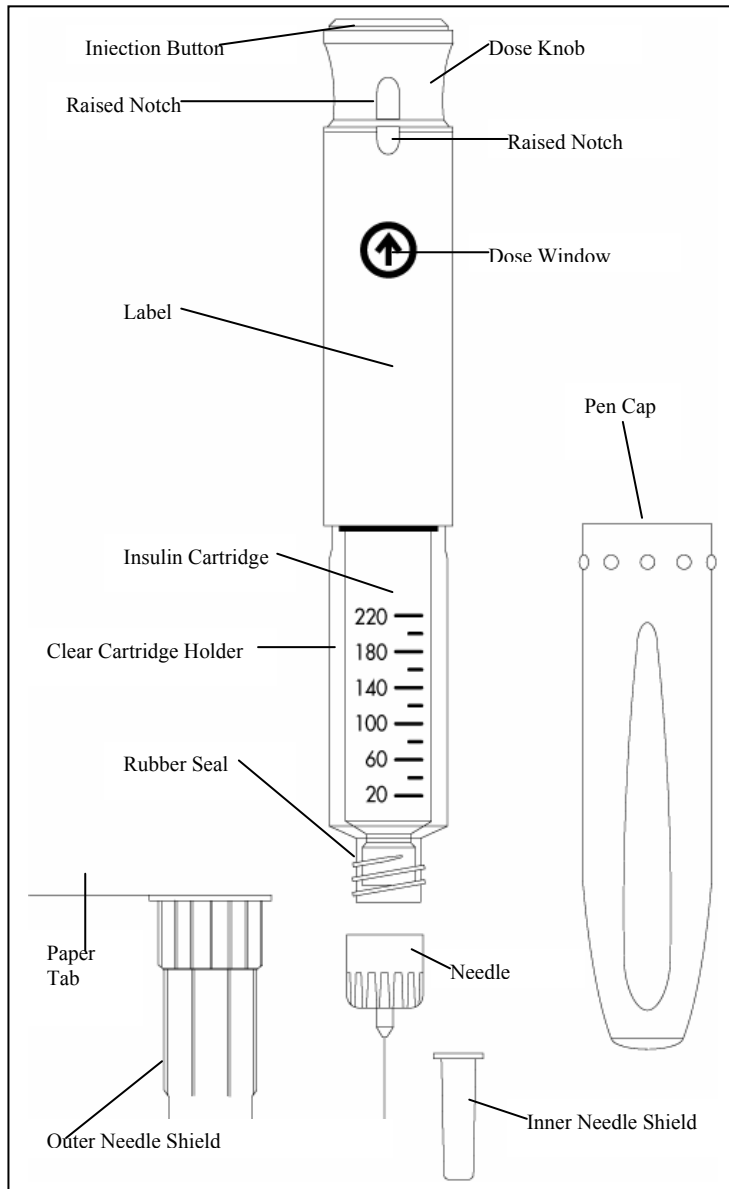

Important Notes

- **Please read these instructions carefully before using your Pen. Failure to follow these instructions completely, including the priming step, may result in a wrong dose.**
- Use a new needle for each injection.
- Be sure a needle is attached to the Pen before priming, setting (dialing) the dose and injecting your insulin.
- **The Pen must be primed before each injection to make sure the Pen is ready to dose.** Performing the priming step is important to confirm that insulin comes out when you push the injection button, and to remove air that may collect in the insulin cartridge during normal use. **See Section III. *Priming the Pen*, pages 10-13.**
- **If you do not prime, you may receive a wrong dose.**
- The numbers on the clear cartridge holder give an estimate of the amount of insulin remaining in the cartridge. Do not use these numbers for measuring an insulin dose.
- Do not share your Pen.

Important Notes (Continued)

- Keep your Pen out of the reach of children.
- Pens that have not been used should be stored in a refrigerator but not in a freezer. Do not use a Pen if it has been frozen. Refer to the *Information for the Patient* insert for complete storage instructions.
- After a Pen is used for the first time, it should **NOT** be refrigerated but should be kept at room temperature [below 86°F (30°C)] and away from direct heat and light.
- An unrefrigerated Pen should be discarded according to the time specified in the *Information for the Patient* insert, even if it still contains insulin.
- Never use a Pen after the expiration date stamped on the label.
- Do not store your Pen with the needle attached. Doing so may allow insulin to leak from the Pen and air bubbles to form in the cartridge. Additionally, with suspension (cloudy) insulins, crystals may clog the needle.
- Always carry an extra Pen in case yours is lost or damaged.
- Dispose of empty Pens as instructed by your Health Care Professional and without the needle attached.
- This Pen is not recommended for use by blind or visually impaired persons without the assistance of a person trained in the proper use of the product.
- **Any changes in insulin should be made cautiously and only under medical supervision.**

I. Preparing the Pen

1. Before proceeding, refer to the *Information for the Patient* insert for instructions on checking the appearance of your insulin.
2. Check the label on the Pen to be sure the Pen contains the type of insulin that has been prescribed for you.
3. Always wash your hands before preparing your Pen for use.
4. Pull the Pen cap to remove.

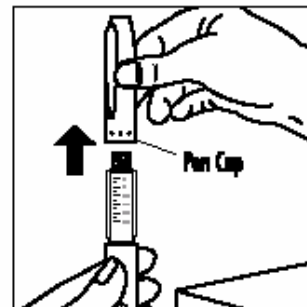

I. Preparing the Pen (Continued)

5. If your insulin is a suspension (cloudy):

- a. Roll the Pen back and forth 10 times then perform step b.

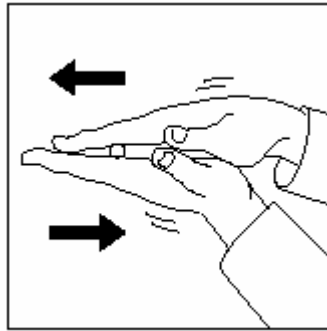

- b. Gently turn the Pen up and down 10 times until the insulin is evenly mixed.

Note: Suspension (cloudy) insulin cartridges contain a small glass bead to assist in mixing.

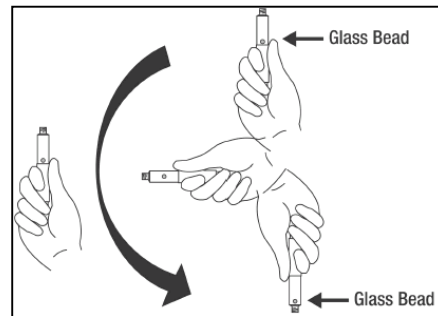

6. Use an alcohol swab to wipe the rubber seal on the end of the Pen.

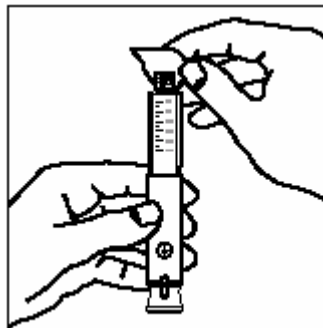

II. Attaching the Needle

This device is suitable for use with Becton Dickinson and Company's insulin pen needles.

1. Always use a new needle for each injection. Storing the Pen with the needle attached may allow insulin to leak from the Pen and air bubbles to form in the cartridge.
2. Remove the paper tab from the outer needle shield.

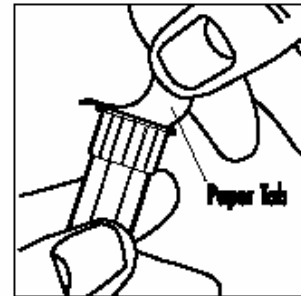

3. Attach the capped needle onto the end of the Pen by turning it clockwise until tight.

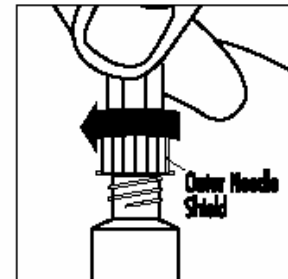

II. Attaching the Needle (Continued)

4. Hold the Pen with the needle pointing up and remove the **outer needle shield**. **Keep it to use during needle removal.**

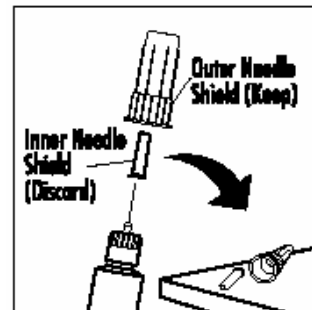

5. **Remove the inner needle shield and discard.**

III. Priming the Pen

- **Always use a new needle for each injection.**
- **The Pen must be primed before each injection to make sure the Pen is ready to dose.**
Performing the priming step is important to confirm that insulin comes out when you push the injection button, and to remove air that may collect in the insulin cartridge during normal use.
- **If you do not prime, you may receive a wrong dose.**

1. You cannot prime your Pen until you can see the arrow (→) in the dose window. If a number or a blank space is in the dose window, push in the injection button completely until a diamond (◆) or arrow (→) is seen. When diamonds (◆) can be seen in the dose window, turn the dose knob clockwise until the arrow (→) is seen and the notches on the Pen and dose knob are in line.

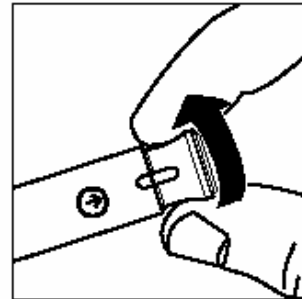

III. Priming the Pen (Continued)

2. With the arrow in the dose window, pull the dose knob out in the direction of the arrow until a “0” is seen in the dose window.

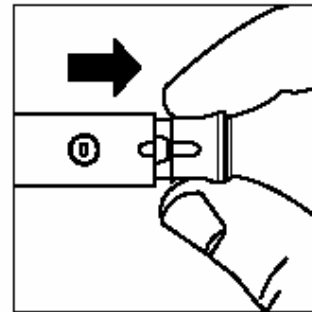

3. Turn the dose knob clockwise until the number “2” is seen in the dose window. If the number you have dialed is too high, simply turn the dose knob backward until the number 2 is seen in the dose window.

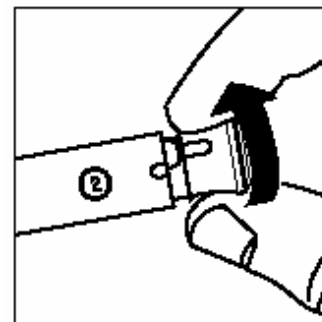

III. Priming the Pen (Continued)

4. Hold your Pen with the needle pointing up. Tap the clear cartridge holder gently with your finger so any air bubbles collect near the top. Using your thumb, if possible, push in the injection button completely and maintain pressure until the insulin flow stops. You should see either a drop or a stream of insulin come out of the tip of the needle. If insulin does not come out of the tip of the needle, repeat steps 1 through 4. If after several attempts insulin does not come out of the tip of the needle, refer to the “Questions and Answers” section at the end of this manual.

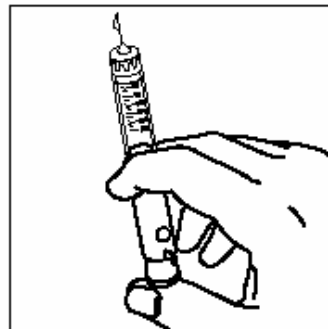

III. Priming the Pen (Continued)

5. At the completion of the priming step, a diamond (◆) must be seen in the dose window.

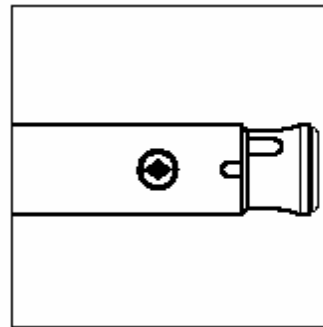

Note: A small air bubble may remain in the cartridge after the completion of the priming step. If you have properly primed the Pen, this small air bubble will not affect your insulin dose.

6. Now you are ready to set your dose. See next page.

IV. Setting a Dose

- **Always use a new needle for each injection. Storing the Pen with the needle attached may allow insulin to leak from the Pen and air bubbles to form in the cartridge.**
 - **Caution: Do not push in the injection button while setting your dose. Failure to follow these instructions carefully may result in an inaccurate insulin dose.***
1. Pen has been primed and a diamond (◆) can be seen in the dose window.
 2. Turn the dose knob clockwise until the arrow (→) is seen in the dose window and the notches on the Pen and dose knob are in line.

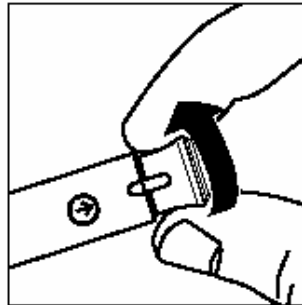

* See Page 16.

IV. Setting a Dose (Continued)

3. With the arrow (→) in the dose window, pull the dose knob out in the direction of the arrow until a “0” is seen in the dose window. A dose cannot be dialed until the dose knob is pulled out.

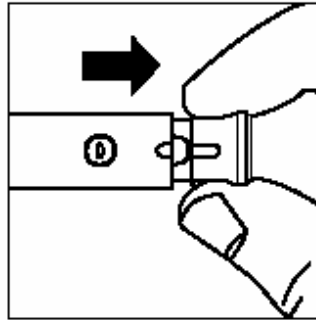

4. Turn the dose knob clockwise until your dose is seen in the dose window. If the dose you have dialed is too high, simply turn the dose knob backward until the correct dose is seen in the dose window.

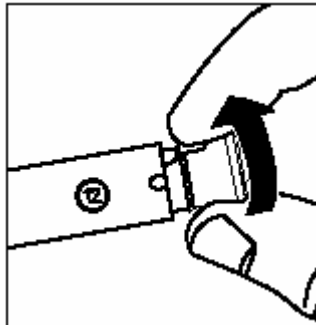

5. If you cannot dial a full dose, see the “Questions and Answers” section at the end of this manual.

V. Injecting a Dose

- **Always use a new needle for each injection. Storing the Pen with the needle attached may allow insulin to leak from the Pen and air bubbles to form in the cartridge.**
- **Caution: Do not attempt to change the dose after you begin to push in the injection button. Failure to follow these instructions carefully may result in an inaccurate insulin dose.***
- **The effort needed to push in the injection button may increase while you are injecting your insulin dose. If you cannot completely push in the injection button, refer to the “Questions and Answers” section at the end of this manual.**

* If you have set (dialed) a dose and pushed in the injection button without a needle attached or if no insulin comes out of the needle, see the “Questions and Answers” section.

V. Injecting a Dose (Continued)

1. Wash hands. Prepare the skin and use the injection technique recommended by your Health Care Professional.

Inject the insulin by using your thumb, if possible, to completely push in the injection button. When the injection button has been completely pushed in (**a diamond (◆) or arrow (→) must be seen in the dose window to indicate that the injection button has been completely pushed in**), continue to hold it down and count **slowly** to 5. After dispensing a dose, pull the needle out and apply gentle pressure over the injection site for several seconds. Do not rub the area.

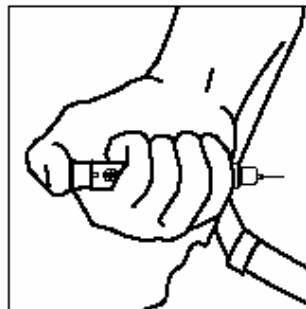
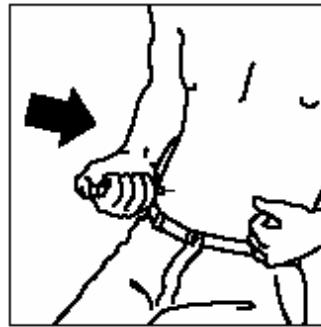

VI. Following an Injection

Do not store or dispose of the Pen with a needle attached. Storing the Pen with the needle attached may allow insulin to leak from the Pen and air bubbles to form in the cartridge.

1. Check that the injection button has been completely pushed in and you can see a diamond (◆) or arrow (→) in the dose window. If a diamond (◆) or arrow (→) cannot be seen in the dose window, your full dose has not been delivered. Contact your Health Care Professional immediately for additional instructions.

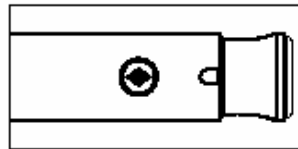

2. Carefully replace the **outer needle shield**.

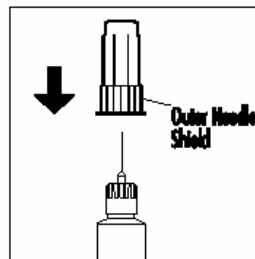

VI. Following an Injection (Continued)

3. Remove the capped needle by turning it counterclockwise and dispose of it as directed by your Health Care Professional. Place the used needle in a puncture-resistant disposable container and properly dispose of it as directed by your Health Care Professional.

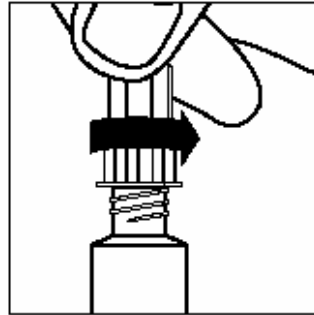

4. Replace the cap on the Pen.

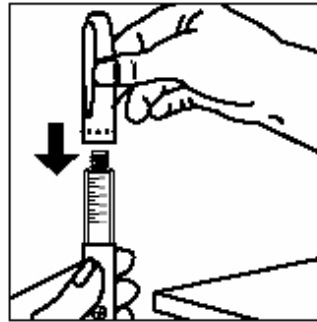

5. The Pen that you are using should **NOT** be refrigerated but kept at room temperature [below 86°F (30°C)] and away from direct heat and light. It should be discarded according to the time specified in the *Information for the Patient* insert, even if it still contains insulin.

Questions and Answers

Problem	Action
Dose dialed and injection button pushed in without a needle attached.	To obtain an accurate dose you must: 1) Attach a new needle. 2) Push in the injection button completely (even if a “0” is seen in the window) until a diamond (◆) or arrow (→) is seen in the dose window. 3) Prime the Pen.
Insulin does not come out of the needle.	To obtain an accurate dose you must: 1) Attach a new needle. 2) Push in the injection button completely (even if a “0” is seen in the window) until a diamond (◆) or arrow (→) is seen in the dose window. 3) Prime the Pen.

Questions and Answers (Continued)

Problem	Action
Wrong dose (too high or too low) dialed.	If you have not pushed in the injection button, simply turn the dose knob backward or forward to correct the dose.
Not sure how much insulin remains in the cartridge.	Hold the Pen with the needle end pointing down. The scale (20 units between marks) on the clear cartridge holder shows an estimate of the number of units remaining. These numbers should not be used for measuring an insulin dose.

Questions and Answers (Continued)

Problem	Action
Full dose cannot be dialed.	The Pen will not allow you to dial a dose greater than the number of insulin units remaining in the cartridge. For example, if you need 31 units and only 25 units remain in the Pen, you will not be able to dial past 25. Do not attempt to dial past this point. (The insulin that remains is unusable and not part of the 300 units.) If a partial dose remains in the Pen you may either: 1) Give the partial dose and then give the remaining dose using a new Pen, or 2) Give the full dose with a new Pen.
A small amount of insulin remains in the cartridge but a dose cannot be dialed.	The Pen design prevents the cartridge from being completely emptied. The Pen has delivered 300 units of usable insulin.

Questions and Answers (Continued)

Problem	Action
Cannot completely push in the injection button when priming the Pen or injecting a dose.	<ol style="list-style-type: none">1) Needle is not attached or is clogged.<ol style="list-style-type: none">a. Attach a new needle.b. Push in the injection button completely (even if a “0” is seen in the window) until a diamond (◆) or arrow (→) is seen in the dose window.c. Prime the Pen.2) If you are sure insulin is coming out of the needle, push in the injection button more slowly to reduce the effort needed and maintain a constant pressure until the injection button is completely pushed in.

**For additional information call,
1-888-88-LILLY**

Literature issued XXX 2003

Eli Lilly and Company, Indianapolis, IN 46285, USA

A3.0 NL 3730 AMP

PRINTED IN USA

This label may not be the latest approved by FDA.
For current labeling information, please visit <https://www.fda.gov/drugsatfda>

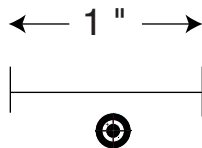

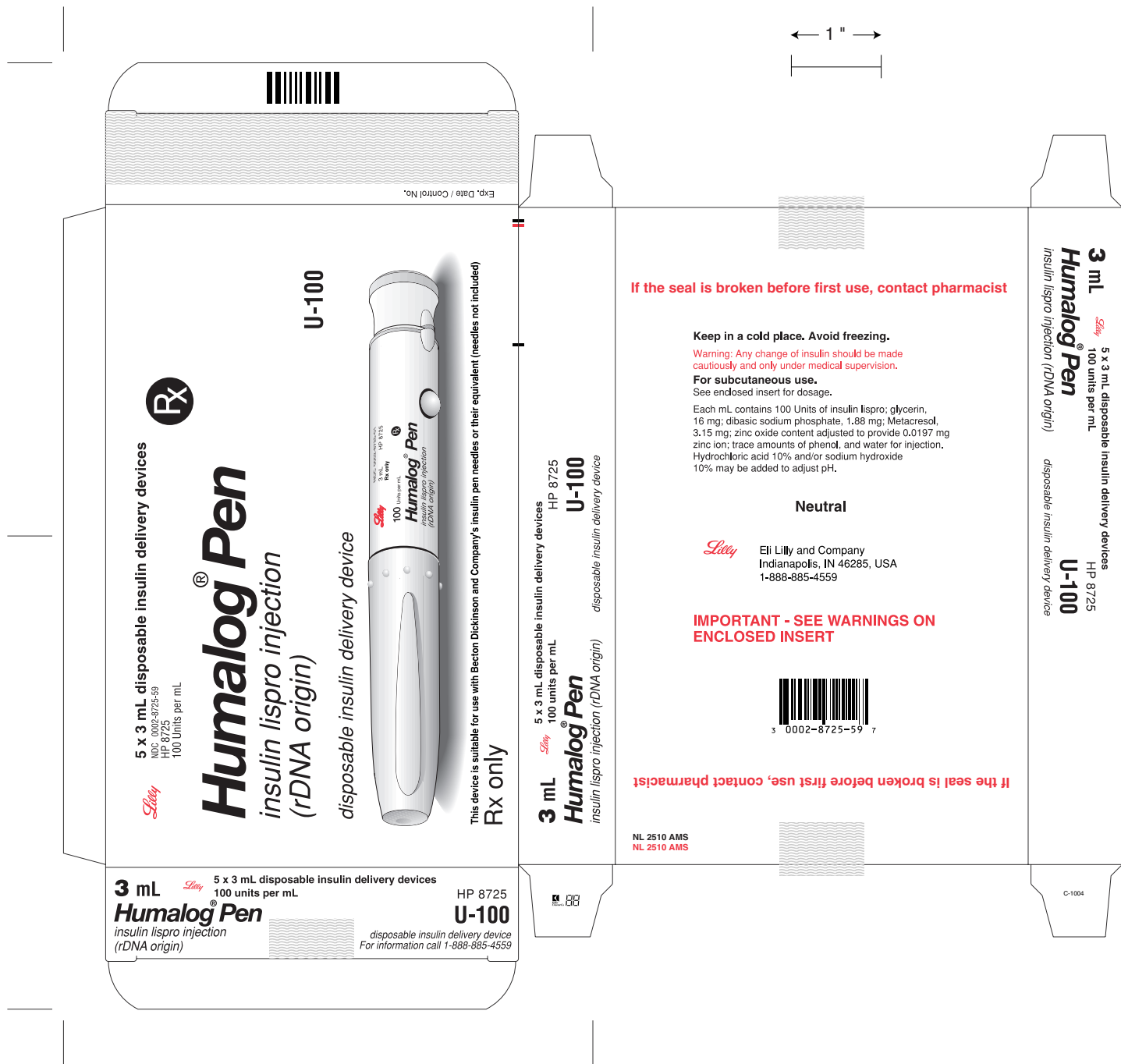

5 x 3 mL disposable insulin delivery devices

NDC 0002-8725-59
HP 8725
100 Units per mL



Humalog Pen[®]

insulin lispro injection
(rDNA origin)

disposable insulin delivery device



U-100

This device is suitable for use with Becton Dickinson and Company's insulin pen needles or their equivalent (needles not included)

Rx only



Exp. Date / Control No.

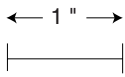

3 mL
Humalog Pen[®]
insulin lispro injection
(rDNA origin)

5 x 3 mL disposable insulin delivery devices
100 units per mL

HP 8725
U-100

disposable insulin delivery device
For information call 1-888-885-4559



5 x 3 mL disposable insulin delivery devices

HP 8725

Humalog Pen[®]

insulin lispro injection (rDNA origin)

U-100

disposable insulin delivery device

NL 2510 AMS
NL 2510 AMS

If the seal is broken before first use, contact pharmacist



3 0002-8725-59 7

Neutral



Eli Lilly and Company
Indianapolis, IN 46285, USA
1-888-885-4559

**IMPORTANT - SEE WARNINGS ON
ENCLOSED INSERT**

Keep in a cold place. Avoid freezing.
Warning: Any change of insulin should be made cautiously and only under medical supervision.
For subcutaneous use.
See enclosed insert for dosage.

Each mL contains 100 Units of insulin lispro; glycerin, 16 mg; dibasic sodium phosphate, 1.88 mg; Metacresol, 3.15 mg; zinc oxide content adjusted to provide 0.0197 mg zinc ion; trace amounts of phenol, and water for injection. Hydrochloric acid 10% and/or sodium hydroxide 10% may be added to adjust pH.

If the seal is broken before first use, contact pharmacist

C-1004

3 mL
Humalog Pen[®]
insulin lispro injection (rDNA origin)
disposable insulin delivery device
U-100
HP 8725
5 x 3 mL disposable insulin delivery devices
100 units per mL